

Article number: 0102193

Description: Retaining ring J290 DIN472  
Spring steel

## Measures

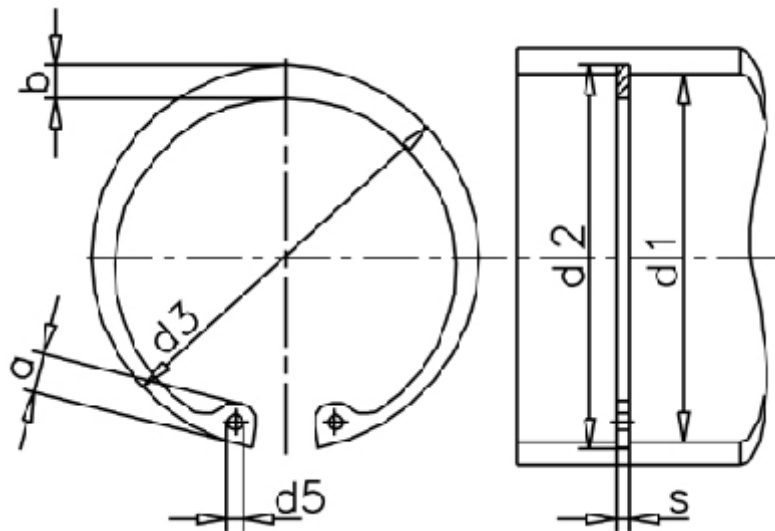

|                     |          |               |          |                |              |
|---------------------|----------|---------------|----------|----------------|--------------|
| a max               | = 16.2   | FN kN         | = 615.00 | t              | = 4.00       |
| AN mm <sup>2</sup>  | = 3695.0 | FRg kN        | = 71.5   | tol            | = +0,81      |
| b                   | = 16.0   | FR kN         | = 482.0  | tol            | = +2,00-0,81 |
| d1                  | = 290    | g             | = 4.0    | tol            | = -0.12      |
| d2                  | = 298.0  | K kN-mm       | = 1104.0 | Tong           | = ZGJ-5      |
| d3                  | = 305.00 | m min         | = 5.15   | Weight kg/1000 | = 415.00     |
| d5 min              | = 5.0    | Nominal drive | = 12.0   |                |              |
| Description = J 290 |          | s             | = 5.00   |                |              |